

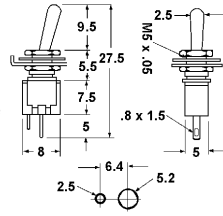

**ULTRA MINIATURE TOGGLE SWITCHES (3A @ 125VAC)**



Single Pole



- 41-310-0 SPST on-off
  - 41-313-0 SPDT on-on
  - 41-323-0 DPDT on-on
- Use -1 for Display Package*



Double Pole

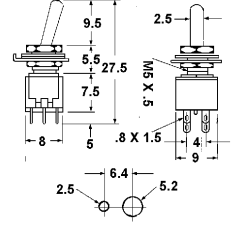

**BAT HANDLE SUB-MINIATURE TOGGLE SWITCH (6A @ 125VAC)**



- 41-513-0 SPDT on-on
  - 41-523-0 DPDT on-on
  - 41-525-0 DPDT on-off-on
- Use -1 for Display Package*

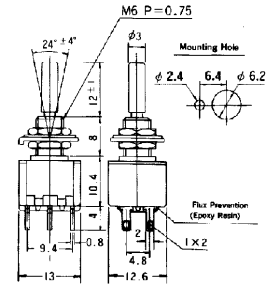
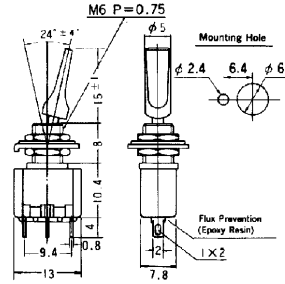

**COLORED VINYL CAPS**

For Sub-Miniature Toggle Switches



- 41-901-0 Black
- 41-902-0 Red
- 41-904-0 Yellow
- 41-906-0 Blue
- 41-909-0 White

**WATERPROOF BOOTS**

M6.3 size for North American made switches -M6 for offshore made switches.



- 41-899-0 M6.3 x .635 thread Package 3
- 41-899-3 M6.3 x .635 thread Package 3
- 41-900-0 M6 x 0.75 thread Package 3
- 41-900-3 M6 x 0.75 thread Package 3

**STANDARD TOGGLE SWITCHES**



3A @ 125V (1.5A @ 250V) with solder terminals.

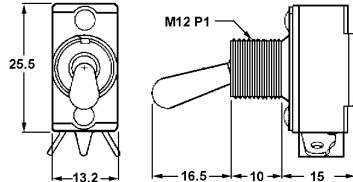

- 42-010-0 SPST on-off
- 42-010-1 Display Package

10 amp @ 125VAC (6 amp @ 250VAC)  
Solder terminals and dress panel nut.

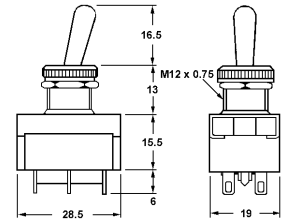

- 42-113-0 SPDT on-on
  - 42-115-0 SPDT on-off-on
  - 42-123-0 DPDT on-on
- Use -1 for Display Package*

10 amp @ 125VAC (6 amp @ 250VAC)  
Solder terminals and dress panel nut.

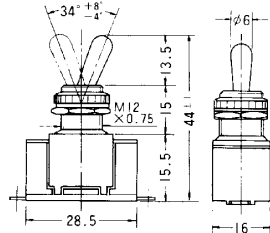

- 42-110-0 SPST on-off
- 42-110-1 Display Package

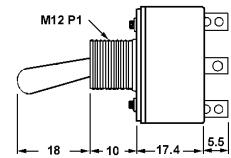
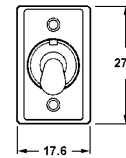

- 42-130-0 DPST on-off 5A/125V CSA
- 42-143-0 DPDT on-on 5A/125V CSA
- 42-145-0 DPDT on-off-on 5A/125V CSA/UL

*Use -1 for Display Package*



3A @ 125V

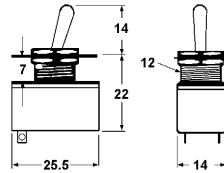

42-210-0 SPST on-off  
42-210-1 Display Package

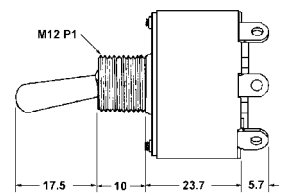
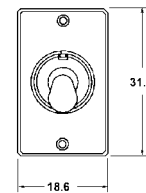

**NKK** AS NOTED

42-340-0 DPDT on-on 10A/125VAC (10A/30VDC) CSA/UL  
42-543-0 DPDT on-on 20A/125VAC (20A/30VDC) CSA/UL  
42-545-0 DPDT on-off-on 20A/125VAC (20A/30VDC) CSA  
Use -1 for Display Package



6A @ 125V

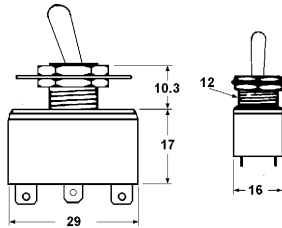

42-223-0 DPDT on-on  
42-223-1 Display Package

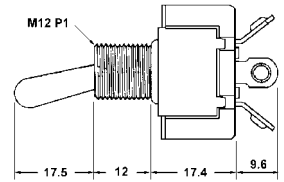
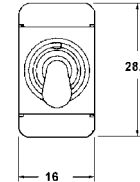

**NKK** AS NOTED

15A/125V 6A/250VAC(20A/30VDC)

42-410-0 SPST on-off CSA/UL  
42-424N-0 SPDT on-on CSA/UL  
42-424-0 SPDT on-(on) CSA  
42-425B-0 SPDT on-off-on CSA/UL  
42-426-0 SPDT on-off-(on) CSA  
42-427-0 SPDT (on)-off-(on) CSA

Use -1 for Display Package



6A @ 125V

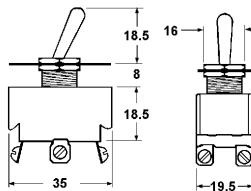

42-225-0 DPDT on-off-on  
42-225-1 Display Package



10A @ 125V  
(6A @ 250V)

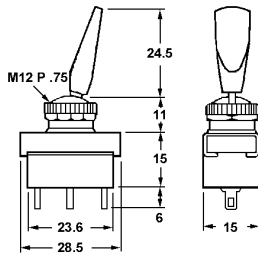

Black plastic bat handle. Solder terminals.

42-310-0 SPST on-off  
42-323-0 DPDT on-on  
Use -1 for Display Package

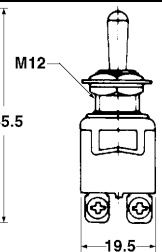
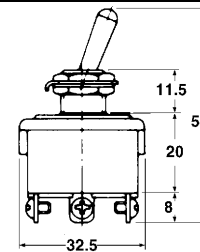

Rating: 15A/125V 10A/250V screw terminals

42-413-0 SPDT on-on  
42-415-0 SPDT on-off-on  
42-423-0 DPDT on-on  
42-425-0 DPDT on-off-on

Use -1 for Display Package

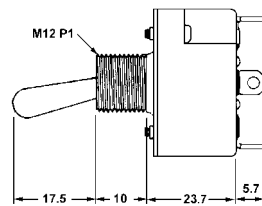
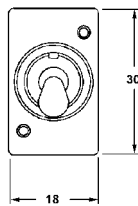

AS NOTED **NKK**

42-310N-0 SPST on-off 10A/125VAC (10A/30VDC) CSA/UL  
42-323N-0 SPDT on-on 10A/125VAC (10A/30VDC) UL  
42-410N-0 SPST on-off 15A/125VAC (20A/30VDC) CSA/UL  
Same style switch but with .250" faston terminals no UL or CSA approvals.  
42-423N-0 SPDT on-on 15A/125VAC (20A/30VDC)  
42-425N-0 SPDT on-off-on 15A/125VAC (20A/30VDC)  
Use -1 for Display Package

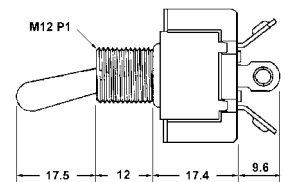
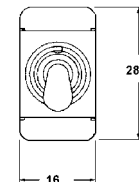

**NKK** AS NOTED

15A/125V 6A/250VAC(20A/30VDC) screw terminals

42-423S-0 SPDT on-on CSA/UL  
42-424S-0 SPDT on-(on) CSA/UL  
42-425S-0 SPDT on-off-on CSA  
42-426S-0 SPDT on-off-(on) CSA/UL  
42-427S-0 SPDT (on)-off-(on) CSA

Use -1 for Display Package

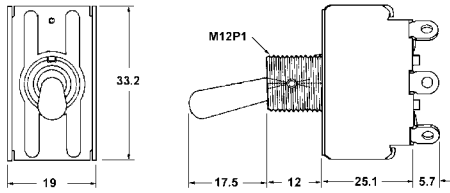

**NKK** AS NOTED **SA** **RU**

- 42-444-0 DPDT on-(on) 15A/125VAC (20A/30VDC) CSA/UL
  - 42-446-0 DPDT on-off-(on) 15A/125VAC (20A/30VDC) UL
  - 42-447-0 DPDT (on)-off-(on) 15A/125VAC (20A/30VDC) UL
  - 42-630-0 DPST on-off 25A/125VAC (25A/30VDC) CSA
  - 42-643-0 DPDT on-on 25A/125VAC (25A/30VDC) CSA
  - 42-645-0 DPDT on-off-on 25A/125VAC (25A/30VDC) CSA
- Use -1 for Display Package*

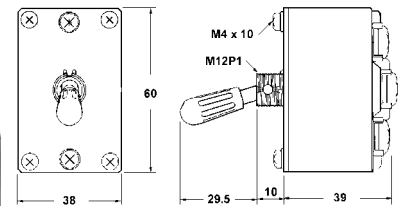

**NKK**

50 Amp @ 125VAC

These high capacity switches are designed to protect contacts by extinguishing the arc which occurs at break. Bar magnets are placed at each end of the switch and their magnetic field opposes the field created by the arcing current, thereby extinguishing the arc.

- 42-843-0 DPDT 50A/125VAC(50A/30VDC)
- Use -1 for Display Package*

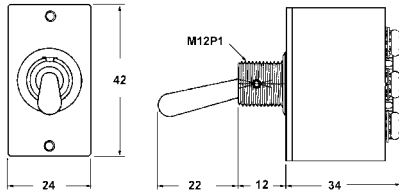

**NKK** **SA** **RU**

- 42-670-0 4PST on-off 25A/125VA (20A/30VDC)
  - 42-683-0 4PDT on-on 25A/125VAC (20A/30VDC)
  - 42-685-0 4PDT on-off-on 25A/125VAC (20A/30VDC)
- Use -1 for Display Package*

**PUSHBUTTON SWITCHES**

6 Amp @250VAC (10A @ 125VAC) with black button.

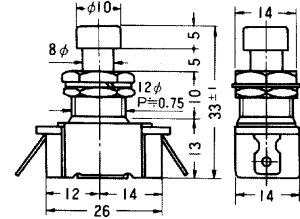

- 44-110-0 SPST on-off Bulk
- 44-110-1 Pkg

6 Amp @ 250VAC (10 Amp @ 125VAC) with chrome button.

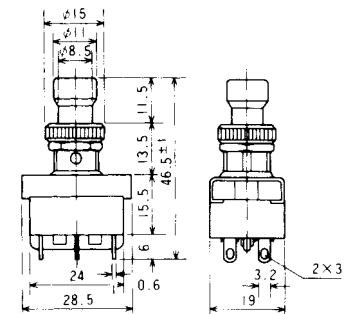

- Alternate Action
- 44-123-0 DPDT on-on Bulk
- 44-123-1 Pkg

3 Amp @ 125VAC with black button

**WATERPROOF BOOTS**



- 42-900-0 for M12 P1 thread
- 42-900-1 Pkg.

**SWITCH PLATE**

- 42-901-0 on-off switchplate for M12 barrel

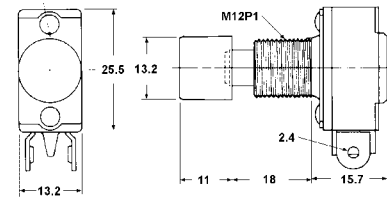

**NKK** **SA**

- 44-201-0 SPST off-(on) N/O Bulk
  - 44-202-0 SPST on-(off) N/C Bulk
- Use -1 for Display Package*

# PUSHBUTTON SWITCHES



15 Amp @125VAC or 250VAC (1/2 HP). Very long life micro switch with black button.

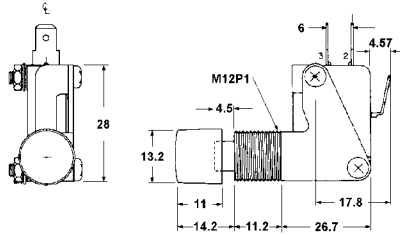

44-241-0 SPDT on-(on) Bulk  
44-241-1 Pkg

15 Amp @ 125VAC (9 Amp @ 250VAC) with black button.

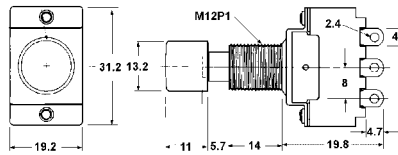

44-250-0 DPDT on-on Bulk  
44-250-1 Pkg



3A @ 125VAC

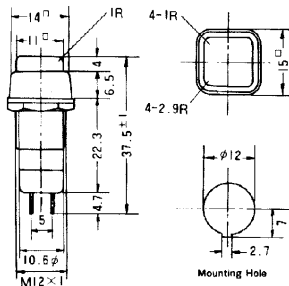

44-480-0 SPST off-(on) N/O red button  
44-481-0 SPST off-(on) N/O black button  
44-482-0 SPST off-on red button  
44-483-0 SPST on-(off) N/C red button

Use -1 for Display Package



3A @ 125VAC  
12mm mounting hole

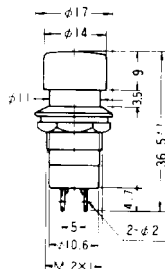

44-490-0 SPST off-on black button  
44-491-0 SPST off-(on) N/O red button  
44-492-0 SPST off-(on) N/O black button  
44-493-0 SPST off-on red button

Use -1 for Display Package



3A @ 125VAC  
16mm mounting hole  
snap-in mounting.

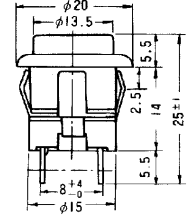

44-530-0 SPST off-(on) N/O white button  
44-531-0 SPST off-(on) N/O black button  
44-532-0 SPST off-(on) N/O red button

Use -1 for Display Package

.5A @ 125VAC Ultra-miniature pushbutton switch

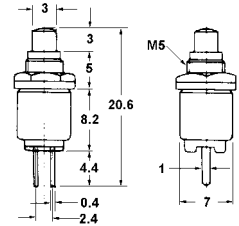

44-541-0 SPST off-(on) N/O black button  
44-542-0 SPST off-(on) N/O red button

Use -1 for Display Package



1 A @ 125VAC

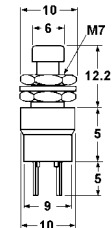

44-551-0 SPST off-(on) N/O black button  
44-552-0 SPST off-(on) N/O red button  
44-553-0 SPST on-(off) N/C black button  
44-554-0 SPST on-(off) N/C red button

Use -1 for Display Package



1 A @ 125VAC

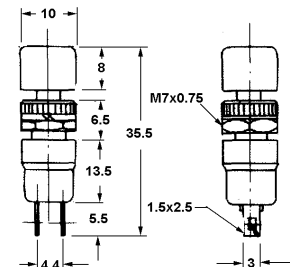

44-570-0 SPST on-(off) N/C red button  
44-571-0 SPST on-(off) N/C black button  
44-572-0 SPST off-(on) N/O red button  
44-573-0 SPST off-(on) N/O black button

Use -1 for Display Package



6A @ 125VAC

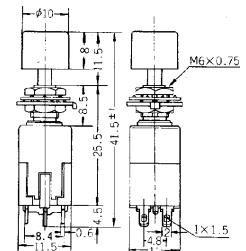

44-611-0 DPDT on-on black button  
44-622-0 SPDT on-on red button

Use -1 for Display Package

**SLIDE SWITCHES**

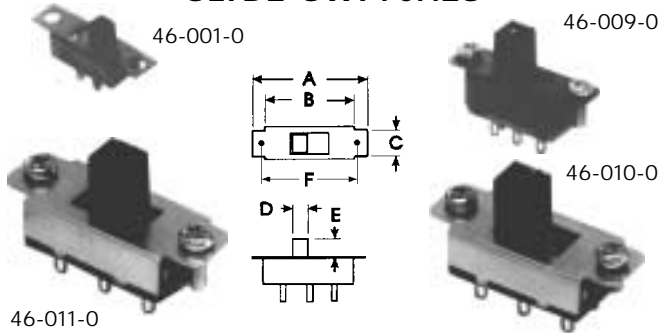

Bulk #	Pkg. #	Current	Poles	Switch	A	B	C	D	E	F
46-001-0	-2	.3A	SPDT	on-on	19	15	5.4	3.2	4	15
46-009-0	-2	.3A	DPDT	on-on	23	19	7.5	4.5	8	19
46-010-0	-2	1A	DPDT	on-on	35	28	13	7	7	31
46-011-0	-2	1A	DPDT	on-off-on	38	32	13	7	7	34

Current ratings are at 125VAC. Dimensions are in mm.

**ROCKER SWITCHES**

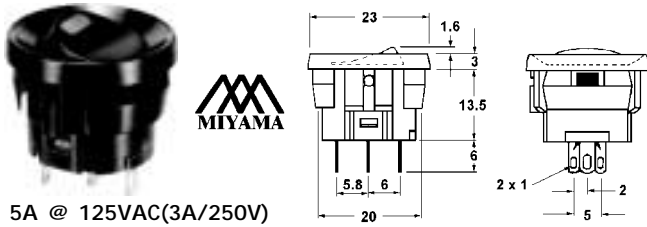

5A @ 125VAC(3A/250V)

Single hole snap-in mount with LED indicator.  
LED requires external limit resistor.

- 46-102-0 SPST on-off black button red LED
- 46-103-0 SPST on-off black button green LED
- 46-104-0 SPST on-off black button yellow LED

Use -1 for Display Package

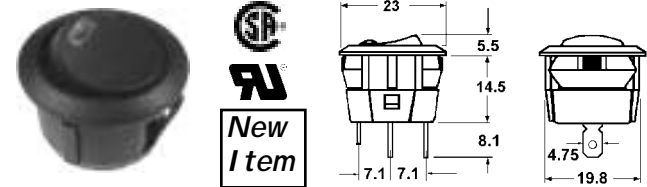

10A @ 125VAC(6A/250V)

Single hole snap-in mount with LED indicator.  
LED requires external limit resistor.

- 46-102J-0 SPST on-off black button red LED
- 46-103J-0 SPST on-off black button green LED
- 46-104J-0 SPST on-off black button yellow LED

Use -1 for Display Package

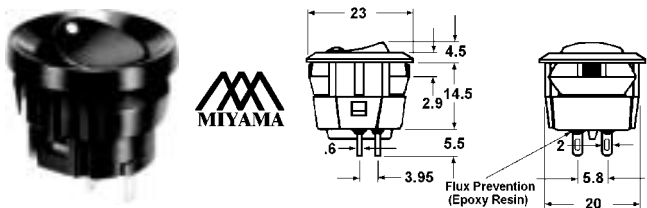

Single hole snap-in mount. 5A @ 125VAC (3A @ 250VAC)

- 46-100-0 SPST on-off black button white dot
- 46-101-0 SPST on-off red button white dot
- 46-108-0 SPDT on-on black button white dot
- 46-124-0 DPDT on-on black button white dot

Use -1 for Display Package

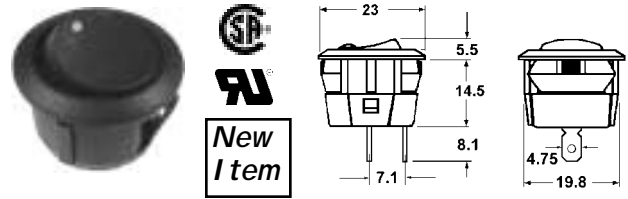

Single hole snap-in mount. 10A @ 125VAC (6A @ 250VAC)

- 46-100J-0 SPST on-off black button white dot
- 46-108J-0 SPDT on-on black button white dot

Use -1 for Display Package

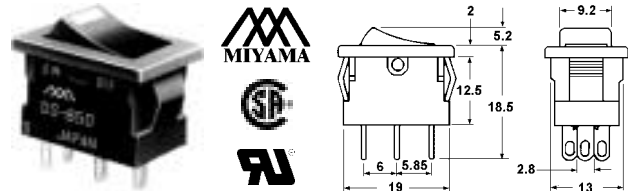

Snap-in mounting 5A @ 125VAC(3A/250V).  
LED requires external limit resistor.

- 46-140-0 SPST on-off red LED indicator
- 46-141-0 SPST on-off green LED indicator

Use -1 for Display Package

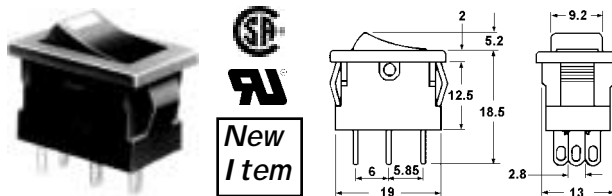

Snap-in mounting 10A @ 125VAC(6A/250V).  
LED requires external limit resistor.

- 46-140J-0 SPST on-off red LED indicator
- 46-141J-0 SPST on-off green LED indicator

Use -1 for Display Package

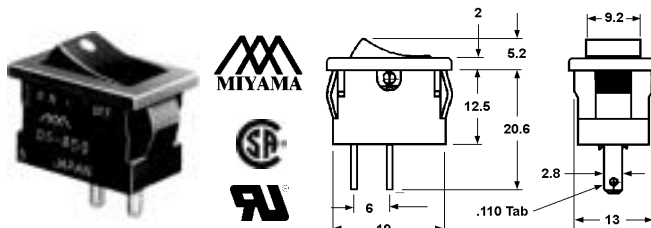

Snap-in mounting 5A @ 125VAC (3A/250V).  
Available with white dot or ON-OFF markings.

- 46-143-0 SPST on-off black button white dot
- 46-144-0 SPST on-off black button ON-OFF

Use -1 for Display Package

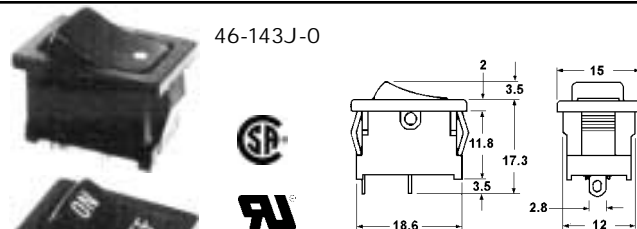

Snap-in mounting

- 46-143J-0 SPST on-off black button white dot
- 46-144J-0 SPST on-off black button ON-OFF

10A @ 125VAC/ (6A/250V)

- 46-143J-0 SPST on-off black button white dot
- 46-144J-0 SPST on-off black button ON-OFF

Use -1 for Display Package



**New Item**

## WEATHERPROOF CAP

Suitable for 46-14x type switches.

**46-149J-0** Waterproof Cap  
Use -5 for Display Package

46-145J-0



**New Item**

46-146J-0

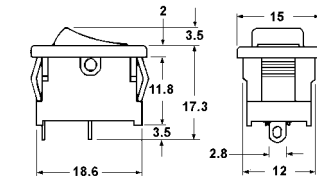

Snap-in mounting

46-145J 10A @ 125VAC/ (6A/250V)  
46-146J 6A @ 125VAC/ (3A/250V)

**46-145J-0** SPDT on-off-on black Int. Symbol  
**46-146J-0** SPST (on)-off black button ON-OFF  
Use -1 for Display Package



**MIYAMA**

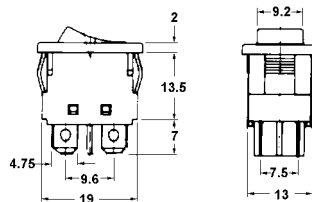

Snap-in mounting 10A @ 250VAC

**46-150-0** DPST on-off black button white dot  
**46-151-0** DPST on-off black button ON-OFF  
Use -1 for Display Package



**MIYAMA**

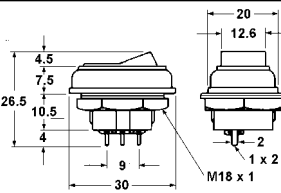

Round 18mm diameter mounting hole 6A @ 125VAC

**46-170-0** SPST on-off white button  
**46-183-0** DPDT on-on white button  
Use -1 for Display Package



**MIYAMA**

**SF**  
**RU**

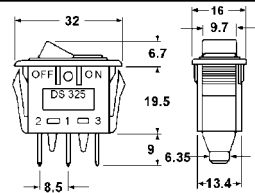

Snap-in mounting with neon indicator. 15A @ 125VAC.  
Mtg. hole: 30.2 x 11mm

**46-190-0** SPST on-off amber rocker  
**46-192-0** SPST on-off red rocker  
Use -1 for Display Package



**SF**  
**RU**

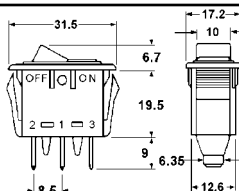

Snap-in mounting with neon indicator. 16A @ 125VAC.  
Mtg. hole: 29 x 13mm

**46-190J-0** SPST on-off amber rocker  
**46-192J-0** SPST on-off red rocker  
Use -1 for Display Package

## KEY SWITCHES

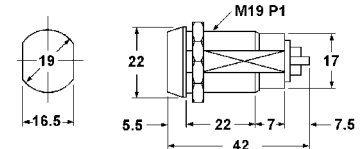

SPST Key removable in either position.  
4 A @ 125VAC

**47-282-0** Bulk assorted keys  
**47-282-1** Pkg assorted keys  
**47-282K-0** Bulk same key  
**47-282-KEY** Blank Key

## MICRO SWITCHES

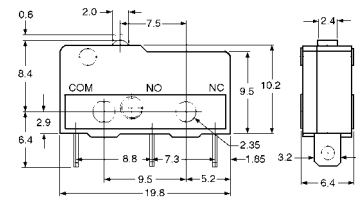

5A @ 125VAC (3A/250V) N/O and N/C contacts.  
Life: 200,000 operations (full load)  
Contact resistance: 30mΩ maximum  
Insulation resistance: 100MΩ min. (500VDC)  
Dielectric strength: 1000VAC for 1 minute

**47-300-0** Bulk **47-300-1** Package



47-400-0

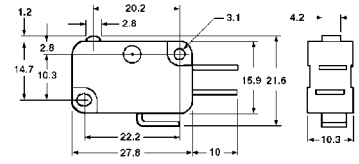

47-402-0

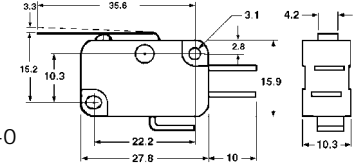

47-406-0

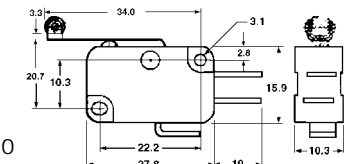

47-403-0

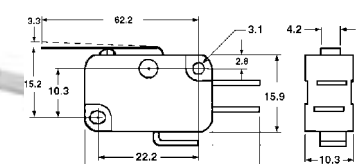

15A @ 125VAC or 250VAC

Contact resistance: 15mΩ maximum (initial)  
Insulation resistance: 100MΩ min (@ 500VDC)  
Dielectric strength: 1,000VAC for 1 minute  
Service life mechanical: 1,000,000 operations  
Service life electrical: 100,000 operations (full load)

All have .187" faston terminals and N/O and N/C terminals.

**47-400-0** No actuator  
**47-402-0** 27.5mm actuator  
**47-403-0** 54.1mm actuator  
**47-406-0** 25.9mm roller actuator  
Use -1 for Display Package

**CIRCUIT BREAKERS**



125VAC  
50VDC

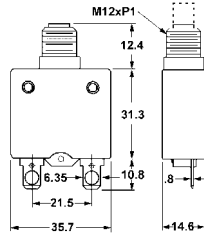

- |          |     |          |     |
|----------|-----|----------|-----|
| 47-503-0 | 3A  | 47-515-0 | 15A |
| 47-504-0 | 4A  | 47-520-0 | 20A |
| 47-505-0 | 5A  | 47-525-0 | 25A |
| 47-510-0 | 10A | 47-530-0 | 30A |

Use -1 for Display Package



**DPDT & 4PDT 5 AMP RELAYS**

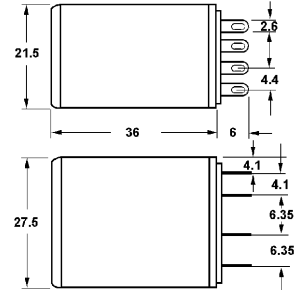

- |                        |                    |
|------------------------|--------------------|
| Contact Resistance:    | 50mΩ max.          |
| Operate Time:          | 25ms max.          |
| Release Time:          | 25ms max.          |
| Insulation Resistance: | 100MΩ min.         |
| Mechanical Life:       | 10M cycles         |
| Electrical Life:       | 100K cycles        |
| Resistive Load:        | 5A@28VDC or 250VAC |

**New Item**

**MAGNETIC SWITCHES**



Magnetic reed switch for security alarms. Has normally open and normally closed switch contacts. Screw terminals.  
12VDC@500ma

- |          |      |
|----------|------|
| 47-600-0 | Bulk |
| 47-600-1 | Pkg. |

**ROTARY SWITCHES**

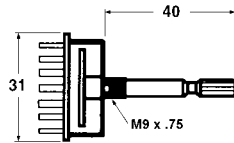

.3 A @ 30VDC non-shorting. Knurled shaft with split.

- |          |        |             |
|----------|--------|-------------|
| 48-511-0 | 1 pole | 12 position |
| 48-512-0 | 2 pole | 6 position  |
| 48-513-0 | 3 pole | 4 position  |
| 48-514-0 | 4 pole | 3 position  |

Use -1 for Display Package

**RELAYS**

**AUTOMOTIVE RELAYS**

**New Item**

12 VDC

- |           |             |
|-----------|-------------|
| 50-836-0  | SPDT 30 AMP |
| 50-836H-0 | SPDT 40 AMP |



**10 AMP OCTAL BASE RELAYS**



**New Item**

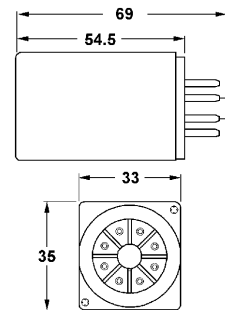

- |                        |                     |
|------------------------|---------------------|
| Contact Resistance:    | 50mΩ max.           |
| Operate Time:          | 20ms max.           |
| Release Time:          | 20ms max.           |
| Insulation Resistance: | 100MΩ min.          |
| Mechanical Life:       | 10M cycles          |
| Electrical Life:       | 100K cycles         |
| Resistive Load:        | 10A@28VDC or 120VAC |



Socket Housing for Auto Relays

**New Item**

c/w 6 terminals

50-920-0 Auto Relay Socket

Part Number	Circuitry	Oper. Volt.	Coil Res.
50-133-0	SPDT	12VDC	120 Ω
50-134-0	SPDT	24VDC	472 Ω
50-139-0	SPDT	120VAC	2250 Ω
50-163-0	DPDT	12VDC	120 Ω
50-164-0	DPDT	24VDC	472 Ω
50-169-0	DPDT	120VAC	2250 Ω

We have many more styles of relays available. Contact us or your local Mode Distributor for additional information.