

CIRCUIT BREAKERS

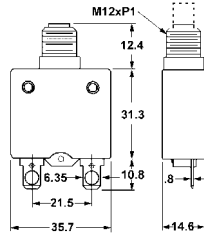

125VAC
50VDC



- | | | | |
|----------|-----|----------|-----|
| 47-503-0 | 3A | 47-515-0 | 15A |
| 47-504-0 | 4A | 47-520-0 | 20A |
| 47-505-0 | 5A | 47-525-0 | 25A |
| 47-510-0 | 10A | 47-530-0 | 30A |

Use -1 for Display Package



DPDT & 4PDT 5 AMP RELAYS

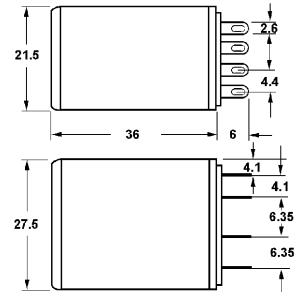

- | | |
|------------------------|--------------------|
| Contact Resistance: | 50mΩ max. |
| Operate Time: | 25ms max. |
| Release Time: | 25ms max. |
| Insulation Resistance: | 100MΩ min. |
| Mechanical Life: | 10M cycles |
| Electrical Life: | 100K cycles |
| Resistive Load: | 5A@28VDC or 250VAC |

New Item

MAGNETIC SWITCHES



Magnetic reed switch for security alarms. Has normally open and normally closed switch contacts. Screw terminals.
12VDC@500ma

- | | |
|----------|------|
| 47-600-0 | Bulk |
| 47-600-1 | Pkg. |

ROTARY SWITCHES

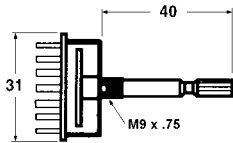

.3 A @ 30VDC non-shorting. Knurled shaft with split.

- | | | |
|----------|--------|-------------|
| 48-511-0 | 1 pole | 12 position |
| 48-512-0 | 2 pole | 6 position |
| 48-513-0 | 3 pole | 4 position |
| 48-514-0 | 4 pole | 3 position |

Use -1 for Display Package

RELAYS

AUTOMOTIVE RELAYS

New Item

12 VDC

- | | |
|-----------|-------------|
| 50-836-0 | SPDT 30 AMP |
| 50-836H-0 | SPDT 40 AMP |



Socket Housing for Auto Relays

New Item

c/w 6 terminals

50-920-0 Auto Relay Socket

10 AMP OCTAL BASE RELAYS



New Item

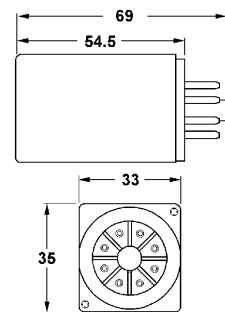

- | | |
|------------------------|---------------------|
| Contact Resistance: | 50mΩ max. |
| Operate Time: | 20ms max. |
| Release Time: | 20ms max. |
| Insulation Resistance: | 100MΩ min. |
| Mechanical Life: | 10M cycles |
| Electrical Life: | 100K cycles |
| Resistive Load: | 10A@28VDC or 120VAC |

Part Number	Circuitry	Oper. Volt.	Coil Res.
50-133-0	SPDT	12VDC	120 Ω
50-134-0	SPDT	24VDC	472 Ω
50-139-0	SPDT	120VAC	2250 Ω
50-163-0	DPDT	12VDC	120 Ω
50-164-0	DPDT	24VDC	472 Ω
50-169-0	DPDT	120VAC	2250 Ω

We have many more styles of relays available. Contact us or your local Mode Distributor for additional information.



Octal Base Socket for 50-13x & 50-16x series on previous page.

New Item

50-910-0 Octal Socket



Socket for 50-06x and 50-09x shown on previous page.

New Item

50-901-0 DPDT PC Mount
 50-902-0 4PDT PC Mount
 50-911-0 DPDT Screw Term.
 50-912-0 4PDT Screw Term.

3 AMP PC RELAYS



New Item

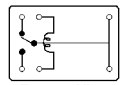
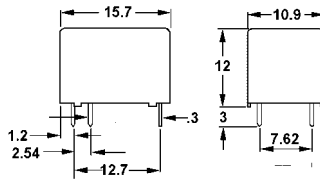

Bottom View

Contact Resistance: 100mΩ max.
 Operate Time: 10ms max.
 Release Time: 5ms max.
 Insulation Resistance: 100MΩ min.
 Mechanical Life: 10M cycles
 Electrical Life: 500K cycles
 Resistive Load: 3A@28VDC or 120VAC

Part Number	Circuitry	Oper. Volt.	Coil Res.
50-330-0	SPDT	5VDC	120 Ω
50-331-0	SPDT	6VDC	180 Ω
50-333-0	SPDT	12VDC	700 Ω
50-334-0	SPDT	24VDC	2800 Ω

1 AMP PC RELAYS (16-PIN DIP)



New Item

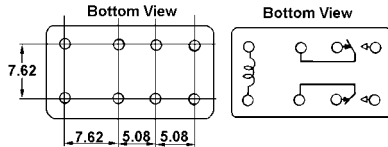
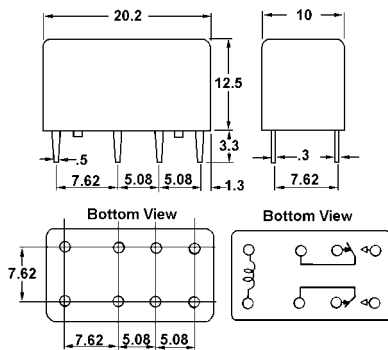

Contact Resistance: 50mΩ max.
 Operate Time: 10ms max.
 Release Time: 4ms max.
 Insulation Resistance: 100MΩ min.
 Mechanical Life: 100M cycles
 Electrical Life: 100K cycles
 Resistive Load: 1A@30VDC or .3A@125VAC

Part Number	Circuitry	Oper. Volt.	Coil Res.
50-430-0	2C	5VDC	125 Ω
50-433-0	2C	12VDC	720 Ω
50-434-0	2C	24VDC	2880 Ω
50-435-0	2C	48VDC	4600 Ω

10 AMP PC RELAYS

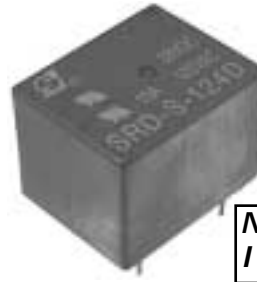

New Item

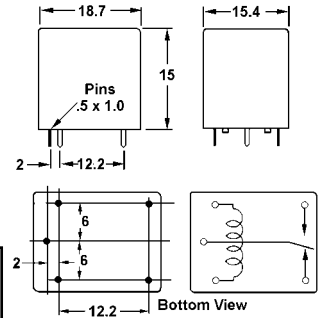

Contact Resistance: 100mΩ max.
 Operate Time: 8ms max.
 Release Time: 5ms max.
 Insulation Resistance: 100MΩ min.
 Mechanical Life: 10M cycles
 Electrical Life: 100K cycles
 Resistive Load: 10A@28VDC or 10A@125VAC
 Inductive Load: 3A@28VDC or 3A@125VAC



Part Number	Circuitry	Oper. Volt.	Coil Res.
50-530-0	SPDT	5VDC	70 Ω
50-533-0	SPDT	12VDC	400 Ω
50-534-0	SPDT	24VDC	1600 Ω
50-535-0	SPDT	48VDC	6400 Ω

PLASTIC CASES



Black plastic project boxes.

Outside dimensions shown

53-520-0 82L x 54W x 31H (plastic cover)
 53-522-0 83L x 54W x 30H (alum. cover)
 53-540-0 103L x 54W x 40H (alum. cover)

Use -1 for Display Package



Inside dimensions shown

53-541-0 99L x 49W x 40H grey ABS plastic
 53-551-0 125L x 60W x 40H grey ABS plastic
 53-571-0 145L x 85W x 50H grey ABS plastic
 53-581-0 180L x 110W x 60H grey ABS plastic

Use -1 for Display Package



53-918-0 275Lx182Wx40H polypropylene box with 18 compartments.